Marketing Cloud Connect Implementation Guide

Salesforce, Spring '23



CONTENTS

MARKETING CLOUD CONNECT IMPLEMENTATION GUIDE	1
SET UP MARKETING CLOUD CONNECT	2
Marketing Cloud Connect Features	3
Prerequisites	9
Marketing Cloud Connect User Types and Permissions	9
Account Configuration for User Data Access	11
Install the Marketing Cloud Connect Managed Package	12
Apply Admin Permissions in Marketing Cloud Connect	13
Set Up Salesforce System User in Marketing Cloud Connect	13
Use Marketing Cloud Connect to Connect Accounts	14
Create Marketing Cloud API User in Marketing Cloud Connect	15
Connect Marketing Cloud API User in Marketing Cloud Connect	16
Assign Business Units	17
Set Up Authentication	17
Designate Default Workflow User	19
Update Field-Level Security	19
Update Page Layouts	20
Launch the Setup Wizard	21
Connect to Marketing Cloud	22
Manage Marketing Cloud Connect Settings	22
Business Unit Management	24
Map Attribute Fields	24
Test the Connection in Marketing Cloud Connect	25
Manage Users	26
MARKETING CLOUD CONNECT USE CASES	29
Multi-Org Account Configuration in Marketing Cloud Connect	29
Email Sends	35
Salesforce Data Extensions in Marketing Cloud Connect	39
Triggered Sends	40
Synchronized Data Sources in Contact Builder	44
Journey Builder Integration	47

MARKETING CLOUD CONNECT IMPLEMENTATION GUIDE

Marketing Cloud Connect combines the digital marketing capabilities of Marketing Cloud with the data management, segmentation, and campaign management tools in Salesforce. Create unitary customer relationships with more data-driven, personalized conversations and the ability to automate the customer journey. With Marketing Cloud Connect, access powerful Marketing Cloud tools directly within Sales or Service Clouds. Ensure a consistent branding and messaging experience, while engaging customers in relevant conversations, and ultimately driving more leads into Salesforce.

Who This Guide Is For

This guide is for Salesforce CRM and Marketing Cloud admins to implement Marketing Cloud Connect and configure specific features.

Before You Start

Review the feature list in this guide to consider how Marketing Cloud Connect works with specific Salesforce editions and features.

Marketing Cloud Connect is available in Salesforce Unlimited, Enterprise, Performance Editions, or Developer Edition Sandbox. Marketing Cloud Connect is available in Marketing Cloud Core Edition, Advanced Edition, Agency Edition, Enterprise 1.0 Lock and Publish, Enterprise 2.0 Edition, Reseller Edition, or Marketing Cloud Sandbox.

Lightning Experience is not supported for Marketing Cloud Connect features. Those using Lightning Experience with Salesforce are automatically redirected to Salesforce Classic when any Marketing Cloud Connect tabs are clicked. Lightning Professional Edition is supported by Salesforce Integration V2 and not supported by Marketing Cloud Connect. Government Cloud requires a custom installation. To schedule, contact your account executive at least 30 days before planned installation. Marketing Cloud Connect doesn't support CipherCloud.

SET UP MARKETING CLOUD CONNECT

Review the minimum system requirements and key Marketing Cloud Connect concepts to understand user types. Choose a data access option for configuration. Install the latest managed package and begin the setup process.

[Marketing Cloud Connect Features](#)

Learn about edition compatibility with Marketing Cloud Connect and what features are available.

[Prerequisites](#)

Marketing Cloud admin and Sales or Service Cloud admin reviews these prerequisites before installing Marketing Cloud Connect.

[Marketing Cloud Connect User Types and Permissions](#)

Marketing Cloud and Sales or Service Cloud admins learn the types of users and permissions associated with Marketing Cloud Connect, which is essential for correct configuration.

[Account Configuration for User Data Access](#)

Marketing Cloud administrator and Sales or Service Cloud administrator review these options for configuring Marketing Cloud Connect data. Choose to set the account as scope by user or non-scope by user.

[Install the Marketing Cloud Connect Managed Package](#)

Sales or Service Cloud administrators review these instructions to install the Marketing Cloud Connect managed package.

[Apply Admin Permissions in Marketing Cloud Connect](#)

Apply administrative permissions to the Marketing Cloud Connect administrator user. These permissions allow the Sales or Service Cloud administrator to set up Marketing Cloud Connect.

[Set Up Salesforce System User in Marketing Cloud Connect](#)

The Sales or Service Cloud administrator creates the Salesforce System User. This user connects the accounts for Marketing Cloud Connect configuration.

[Use Marketing Cloud Connect to Connect Accounts](#)

Connect your Marketing Cloud account to the corresponding Sales or Service Cloud org at the account level to continue Marketing Cloud Connect setup.

[Create Marketing Cloud API User in Marketing Cloud Connect](#)

Create an Marketing Cloud API user in Marketing Cloud Connect.

[Connect Marketing Cloud API User in Marketing Cloud Connect](#)

Connect the Marketing Cloud API user to the Salesforce system user to enable core system communication activities in Marketing Cloud Connect. These activities include pushing tracking data from the Marketing Cloud into your Sales or Service Clouds.

[Assign Business Units](#)

For Marketing Cloud Enterprise 2.0 accounts, assign applicable business units to the Marketing Cloud API user. The Marketing Cloud Connect API user's business unit access in Marketing Cloud determines which business units are available for use within Sales or Service Cloud.

[Set Up Authentication](#)

Complete these tasks to set up connected app authentication for Marketing Cloud Connect.

[Designate Default Workflow User](#)

Complete the steps for designating a default workflow user as part of the CRM configuration of Marketing Cloud Connect.

[Update Field-Level Security](#)

Change field-level security making the email opt-out field visible on leads and contacts, which is a requirement for sending Marketing Cloud emails through Marketing Cloud Connect.

[Update Page Layouts](#)

Add email and mobile send tracking to contact and lead pages to continue configuration of Sales and Service Cloud for Marketing Cloud Connect.

[Launch the Setup Wizard](#)

To configure Marketing Cloud Connect in Sales or Service Cloud, launch the setup wizard in Salesforce Classic UI.

[Connect to Marketing Cloud](#)

The Sales or Service Cloud admin connects the Sales or Service Cloud account with the Marketing Cloud account using the Marketing Cloud API user credentials. This task completes the account-level connection for Marketing Cloud Connect.

[Manage Marketing Cloud Connect Settings](#)

Admins access Marketing Cloud Connect settings and send configuration by navigating to the Marketing Cloud object in the Sales or Service Cloud. Admins can configure these settings, including sends, tracking, users, and business units, after the installation and setup process to enable sending through Marketing Cloud Connect. Edit settings anytime.

[Business Unit Management](#)

Marketing Cloud Connect admins follow these steps to map business units from Marketing Cloud Enterprise 2.0 accounts across clouds to enable them in Marketing Cloud Connect. Not sure what type of account you have? Review Marketing Cloud editions for more information.

[Map Attribute Fields](#)

To personalize communications, map Sales Cloud Contact, Lead, and Account objects within the Marketing Cloud to share attributes across the clouds and enable personalization for Marketing Cloud Connect communications. Multi-org doesn't support Web Collect or custom field and attribute mapping.

[Test the Connection in Marketing Cloud Connect](#)

Complete these steps to ensure Marketing Cloud Connect is set up properly for sending. Create an email in Marketing. Next, create a lead and report for this test. Send the email from the Email Sends object in Sales Cloud, using the lead and report you created. Verify that the test completed.

[Manage Users](#)

After completing the Marketing Cloud Connect installation and setup, integrate Marketing Cloud and Sales or Service Cloud users to enable access to Marketing Cloud Connect.

Marketing Cloud Connect Features

Learn about edition compatibility with Marketing Cloud Connect and what features are available.

Table 1: Connector Versions for Marketing Cloud

Connector Version	Marketing Cloud Connect
Integration Version Notes	Our newest version, previously called V5, is for all Marketing Cloud customers using Salesforce Enterprise Edition or higher.

Table 2: Supported Marketing Cloud Packages





Marketing Cloud Package	Marketing Cloud Connect
Basic	
Pro	
Corporate	
Enterprise	

Table 3: Supported Marketing Cloud Editions

Marketing Cloud Edition (Legacy Terminology)	Marketing Cloud Connect
Core	
Advanced	
Agency	
Enterprise 1.0 Lock & Publish	See Note
Enterprise 1.0 On Your Behalf	See Note
Enterprise 2.0	
Marketing Cloud Sandbox	

 **Note:** Enterprise 1.0 Lock & Publish account functions as a Core account for compatibility with Marketing Cloud Connect. Enterprise 1.0 On Your Behalf isn't supported. Customers can simulate the On Your Behalf use case by sending from the record owner. The record owner can see tracking.

Table 4: Supported Salesforce Editions

Salesforce Edition	Marketing Cloud Connect
Professional	-
Enterprise	
Performance	
Unlimited	
Salesforce Developer Edition Sandbox	



 **Note:** CloudForce.com and Lightning Platform orgs aren't supported. Enable Custom Platform Events in your org to ensure that the managed package installs correctly.

Table 5: Supported User Interfaces

User Interface	Marketing Cloud Connect
Salesforce Classic	
Lightning Experience	See note

 **Note:** Lightning Experience isn't supported for Marketing Cloud Connect features. Those using Lightning Experience with Salesforce are automatically redirected to Salesforce Classic when Marketing Cloud Connect tabs are clicked.

Table 6: Account Configuration Features









Account Configuration	Marketing Cloud Connect
Manage Business Units in Salesforce	 (Enterprise 2.0)
Manage Tracking Data Storage Options	
Manage Reply To Options	
Manage Subscriber Visibility Options	Scope by User and Non-Scope by User
Manage Send Classifications	
Connected App Authentication	
Multi-Org Configuration	

Table 7: Subscriber Features

Subscribers	Marketing Cloud Connect
Profile Center	 (email only)
Custom Profile Center	Recommended for Journey Builder customers
Subscription Center	 (Marketing Cloud based sends)





Subscribers	Marketing Cloud Connect
Custom Subscription Center	Recommended
Marketing Cloud Subscriber Status Source	All Subs list
Marketing Cloud-CRM Subscriber Status Sync	Unsubscribes
Subscriber Key	
Data Extensions and Data Relationships	 (sending only)
Synchronized Data Extensions (CRM data synched to Marketing Cloud)	
Suppression Lists	
Send Logging	
SmartCapture	Requires custom Services engagement

Table 8: Email Content Features









Content	Marketing Cloud Connect
Dynamic Content	
Personalization Strings	
Email Send Preview	 (static and dynamic)
AMPscript	
Email Attachments	 (requires AMPscript)
Sender Authentication Package	
International Sends	
A/B Testing	

Table 9: Interaction Features



Interactions	Marketing Cloud Connect
Triggered Emails	
Automation	
Automated Interaction Management (AIM) - Parent of Activities and Programs; reporting, queries, extracts, scheduling	Marketing Cloud email only (imports and user-initiated sends)
Distributed Sending	-

Table 10: Journey Builder Integration Features











Journey Builder Integration	Marketing Cloud Connect
Salesforce Entry Events	
Custom Salesforce Entry Events	
Sales and Service Activities	
Custom Sales and Service Activities	

Table 11: Salesforce CRM Features

More Features in Salesforce CRM	Marketing Cloud Connect
Segmentation / Target Audiences	Campaign / Reports
Single Sends	Leads / Contacts / Person Accounts
Salesforce Exclusions	
Marketing Cloud Suppression Lists	-
Multiple Audience / Exclusions	
View Sent Email Template	
Global Resubscribe	
Remove Duplicate Subscribers (dedupe)	
Dynamic Owner Send "From" user record owner or alias	
Send Classifications	

More Features in Salesforce CRM**Marketing Cloud Connect**

Send to Salesforce Reports or Campaigns from Marketing Cloud



Salesforce Object mapping: Support for Personalization and Dynamic Content



Salesforce Object Sending: Sendable Custom Objects and Entities

-

Detailed Error Logging



Sending Log



Campaign Member Management



Quick Link to Marketing Cloud



Quick Link to Marketing Cloud Email Editor



Salesforce Mobile App Access

-

Table 12: Tracking Features**Tracking****Marketing Cloud Connect**

View Tracking data at the individual and aggregate level (including sends, delivered, bounces (hard, soft, technical), unique opens, total opens, unique clicks, total clicks, and unsubscribes)



View link level detail at the individual and aggregate level (including email name, date sent, date opened, number of clicks, and number of unique clicks)



Rolling or scheduled tracking data updates



Request tracking data on-demand



Tracking suppression



(configurable per job or globally)

View tracking data using charts, graphs, and reports



Journey Builder Engagement Data



Prerequisites

Marketing Cloud admin and Sales or Service Cloud admin reviews these prerequisites before installing Marketing Cloud Connect.

1. Review product features to understand compatibility and versions.
2. Marketing Cloud Connect requires a relationship between a single Marketing Cloud account and one or more Salesforce orgs. Your Marketing Cloud account must be provisioned and enabled for use with Marketing cloud Connect before connection.
3. Subscriber Key is required for Marketing Cloud Connect. If it is not enabled in your Marketing Cloud account, complete a Subscriber Key Migration before proceeding with the connection process.
4. Ensure that four custom tabs are available in your Salesforce org.
5. To use most Marketing Cloud Connect functionality, users need a Marketing Cloud license and a Sales or Service Cloud license.

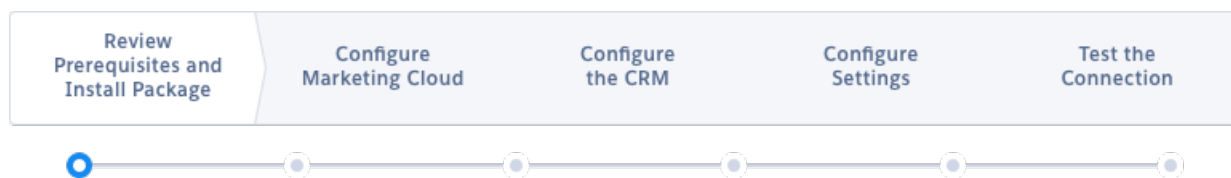

Marketing Cloud Connect User Types and Permissions

Marketing Cloud and Sales or Service Cloud admins learn the types of users and permissions associated with Marketing Cloud Connect, which is essential for correct configuration.

To use most Marketing Cloud Connect functionality, users need a license for the Marketing Cloud and a license for Sales or Service Cloud. Understanding the user types and permissions associated with Marketing Cloud Connect is essential to configuration and they are referenced throughout the documentation.

- **Marketing Cloud Administrator**
The Marketing Cloud admin sets up and configures a Marketing Cloud account and users. This admin works with the Salesforce CRM administrator to install and set up Marketing Cloud Connect.
- **Salesforce CRM (Sales or Service Cloud) Administrator**
The Sales or Service Cloud admin sets up and configures a Salesforce CRM account and users. This admin works with the Marketing Cloud administrator to install and set up Marketing Cloud Connect.
- **Marketing Cloud Connect API User**
The Marketing Cloud Connect API user completes the account-level connection between the Sales or Service Cloud and Marketing Cloud. If possible, use a dedicated system user as the Marketing Cloud Connect API user. If the Sales or Service Cloud org is connected to a Marketing Cloud Enterprise 2.0 account, the Marketing Cloud Connect API user's business unit access in the Marketing Cloud determines which business units are available for use within the Sales or Service Cloud.
- **Salesforce System User**
Formerly called tracking user, this Sales or Service Cloud user is required to complete the account-level connection between the Marketing Cloud and Sales or Service Clouds. This user is the primary mechanism for making Marketing Cloud tracking data available in CRM. It's used exclusively for sending to CRM audiences from the Marketing Cloud in non-scope-by-user accounts. If possible, use a dedicated system user as the Salesforce System User, which does consume a user license.

- **Marketing Cloud Connect Administrator**
This person manages the setup of Marketing Cloud Connect within the Sales or Service Cloud.
- **Marketing Cloud Connect User**
This person accesses Marketing Cloud Connect functionality in the Sales or Service Cloud, Marketing Cloud, or both. Access to Marketing Cloud Connect functionality in the Sales or Service Cloud is managed through CRM permissions and page layouts. Access to Marketing Cloud Connect functionality in the Marketing Cloud is managed through Marketing Cloud Connect permissions. A license for both Marketing Cloud and Sales or Service Cloud is required at a minimum.

CRM Permissions

Grant all Marketing Cloud Connect users these permissions in Sales or Service Cloud:

1. In the Sales or Service Cloud, click **Setup**.
2. Under Administer in the Setup menu, click **Manage Users**.
3. Click **Users**.
4. Create a user or update an existing user with the following settings:
 - a. User License: Salesforce
 - b. Profile: System Administrator
5. Click **Edit** on the Salesforce System User.
6. Select the **Marketing Cloud for AppExchange Admin** permission set.
7. Select the **Marketing Cloud for AppExchange User** permission set.
8. Click **Save**.

Grant these required permissions at the profile level within Sales or Service Cloud. Granting these permissions creates an API user between Marketing Cloud and Sales and Service Clouds using the Marketing Cloud Connect managed package.

Administrative Permissions	General User Permissions
API Enabled	Allow View Knowledge (This permission is checked by default by the system)
API Only User	View Setup and Configuration
Chatter Internal User	Export Reports
Password Never Expires	Report Builder
Schedule Reports	Run Reports
View Help Link	
View Reports in Public Folders	

- **Marketing Cloud for AppExchange Admin Permission**
This Salesforce CRM admin permission lets admins view all data and send to any contact, lead, campaign, or report.
- **Marketing Cloud for AppExchange User Permission**

This non-admin permission lets Salesforce CRM users access the Marketing Cloud Connect interface, enabling them to perform sends. If the account is configured as “scope by user,” users view and send to only the records they own.

- **Connected App Authentication Permission**

The Salesforce CRM admin creates this permission set during Marketing Cloud Connect installation and setup. Assign this permission to all Marketing Cloud Connect users. Connected app manages all cross-cloud authentication from Marketing Cloud into Sales and Service Clouds.

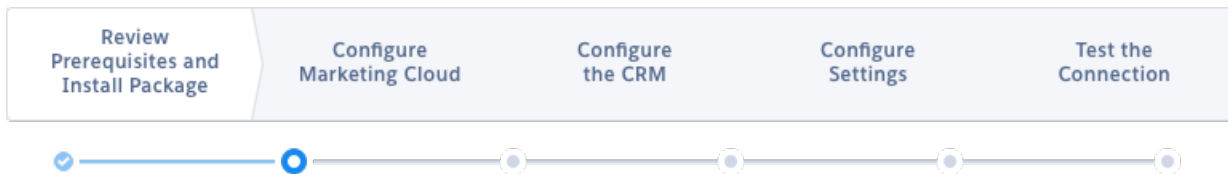

Account Configuration for User Data Access

Marketing Cloud administrator and Sales or Service Cloud administrator review these options for configuring Marketing Cloud Connect data. Choose to set the account as scope by user or non-scope by user.

These two options for Marketing Cloud Connect set the level of data access for your users.

1. Non-scope by user
2. Scope by user

Understanding the important differences between the two account configuration options is critical to determine how you want Marketing Cloud Connect to be used after installation. This option is selected during the Marketing Cloud Connect configuration process and can be altered in the Marketing Cloud Email Studio Setup, under Platform Tools > Apps > Salesforce Integration at any time.

Option 1: Non-Scope by User

This option configures data access on the Salesforce system user, typically an administrator. Choose this option to allow Marketing Cloud Connect users to send to all subscribers in a report or campaign that the Salesforce system user can access. Subscribers are not filtered based on the user running the report.

Examples:

- You create a report based on My Contacts, but the Salesforce system user can't access the contacts in that report. The report is empty and so you can't send to My Contacts. You don't receive an error message, but the subsequent email-send report shows “0” contacts sent.
- You access an existing report containing records shared with other users. You see only your own records on that report. If you send to that report intending only to send to the records you see, you can inadvertently send to other shared records.

Considerations:

- Within the Marketing Cloud, report or campaign lists are not limited to what is visible to the user initiating the send.
- Within the Marketing Cloud, returned subscribers are not limited to what is visible to the user initiating the send.
- Password policies are not in effect, making this configuration easy to maintain because passwords do not expire.
- An administrator can set up a user without entering a password.
- You can mistakenly send to report or campaign members who are not visible to that user without notice.

- This send behavior is the default for v2 accounts, so this option is favorable for existing v2 customers migrating to Marketing Cloud Connect.

Option 2: Scope by User

This option configures data access on the Marketing Cloud Connect user initiating the send. Reports and campaigns that are visible to the user are available for selection as a target audience for sending. The list of subscribers returned is limited to what the user initiating the send has access to view.

Implications on Salesforce Data Extension Import Activities

Import Salesforce data extensions into the Marketing Cloud through Interactions. Create import activities only with Sales or Service Cloud reports you can access. For example, reports in the Marketing Cloud Admin folder in Sales or Service Cloud aren't available for use if you can't access it in Marketing Cloud.

Manual and automated imports behave differently in Scope By User accounts:

- Manual import activities respect scoping, so the number of records that appear in the report are specific to the user who is running the import.
- All automated import activities are executed as the Marketing Cloud API user. Therefore, the number of records reflect the Salesforce system user's level of access to data.

With non-scope by user accounts, imports return results based on the Salesforce system user's data access.

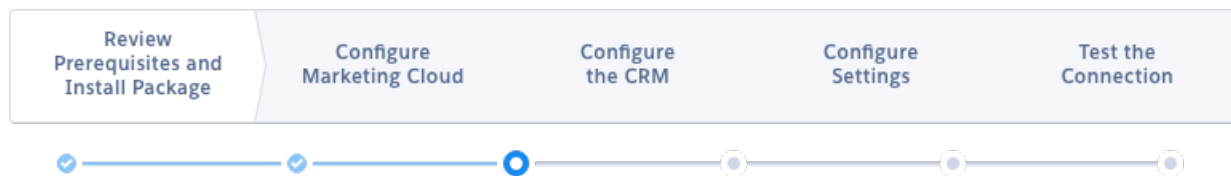

Install the Marketing Cloud Connect Managed Package

Sales or Service Cloud administrators review these instructions to install the Marketing Cloud Connect managed package.

Tip: Review all prerequisite information before beginning the installation process.

1. Install the most recent version of a supported web browser.
2. Paste this URL in your browser, which redirects to the latest managed package version. You are prompted to log in to Salesforce using your administrator credentials.
 - a. Production Org: <https://sfdc.co/MCC>
 - b. Sandbox Org: <https://sfdc.co/MCCSandbox>
- Important:** To ensure that the managed package installs correctly, enable Custom Platform Events in your org. If you are upgrading Marketing Cloud Connect, [review these considerations](#) before installing the latest managed package.
3. After login, select who to install the package for.
4. Click **Install**.

5. If prompted, grant access to these third-party websites.
6. Click **Continue**.

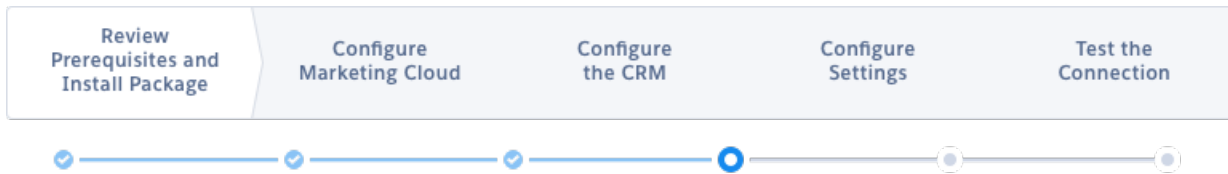

Apply Admin Permissions in Marketing Cloud Connect

Apply administrative permissions to the Marketing Cloud Connect administrator user. These permissions allow the Sales or Service Cloud administrator to set up Marketing Cloud Connect.

1. In the Sales or Service Cloud, click **Setup**.
2. Under Build in the Setup menu, click **Customize**.
3. Click **Users**.
4. Click **Page Layouts**.
5. Edit the user page layout.
6. Add the **Marketing Cloud for AppExchange User** field.
7. Add the **Marketing Cloud for AppExchange Admin** field.
8. Save the user layout changes.
9. Under Administer in the Setup menu, click **Manage Users**.
10. Click **Users**.
11. Edit the Salesforce CRM administrator user.
12. Enable **Marketing Cloud for AppExchange User**.
13. Enable **Marketing Cloud for AppExchange Admin**.
14. Save the user changes.

Check out this [Trailhead: Customize Record Details with Page Layouts](#) for the latest information.

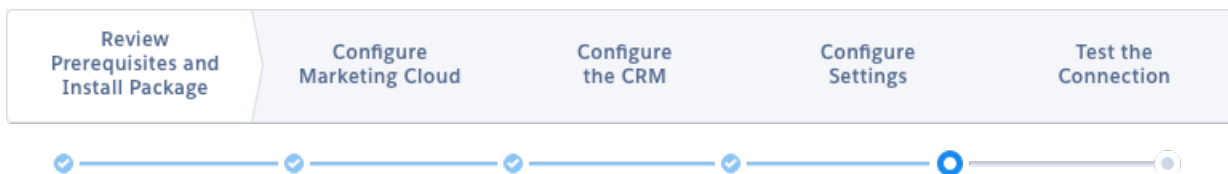

Set Up Salesforce System User in Marketing Cloud Connect

The Sales or Service Cloud administrator creates the Salesforce System User. This user connects the accounts for Marketing Cloud Connect configuration.

The Salesforce system user, formerly called tracking user, makes Marketing Cloud tracking data available in CRM. It's used exclusively for sending to CRM audiences from the Marketing Cloud in non-scope-by-user accounts.

1. In the Sales or Service Cloud, click **Setup**.
2. Under Administer in the setup menu, click **Manage Users**.
3. Click **Users**.
4. Create a user or update an existing user with the following settings:
 - User License: Salesforce
 - Profile: System Administrator
5. Save the user.
6. Edit the Salesforce system user.
7. Apply the **System Administrator** profile to the user.
8. Select **Marketing Cloud for AppExchange Admin**.
9. Select **Marketing Cloud for Appexchange User**.
10. Save the user.



Use Marketing Cloud Connect to Connect Accounts

Connect your Marketing Cloud account to the corresponding Sales or Service Cloud org at the account level to continue Marketing Cloud Connect setup.

- ✔ **Note:** Complete the remaining authentication setup steps during the Configure CRM process to ensure that Connected App Authentication is set up properly.
1. Log in to the Sales or Service Cloud org that you are connecting to the Marketing Cloud, using the Salesforce system user account.
 - ✔ **Note:** During this process, the system automatically connects to any active Salesforce session. To prevent an incorrect connection, log out of any active Sales or Service Cloud sessions, other than the Salesforce system user session used for this process. Closing the tab doesn't end an active session.
 2. Log in to the Marketing Cloud in a separate tab.
 3. Navigate to **Email Studio**.
 4. Click **Admin**.
 5. Click **Salesforce Integration**.
 6. Click **Edit**.
 7. Select **Scope by User** if applicable for your data access configuration.
 8. If prompted, click **Upgrade to Connected App**.

9. Click **Connect Account**.
10. If you aren't logged in to the Sales or Service Cloud as your Salesforce system user in another tab, you are prompted to log in. Click **OK** and log in as the system user.
 -  **Note:** If you are using a company-specific login URL, such as `https://mycompany.my.salesforce.com`, select Use Custom Domain and enter the domain address before entering the Salesforce system user credentials.
11. Click **Allow** to grant access for the Salesforce system user to access the Marketing Cloud account.



Create Marketing Cloud API User in Marketing Cloud Connect

Create an Marketing Cloud API user in Marketing Cloud Connect.

Create the [Marketing Cloud API User](#), which is typically a unique user that connects to the Salesforce System User in Marketing Cloud Connect Setup.

1. In Marketing Cloud, navigate to **Email Studio**.
2. Click **Admin**.
3. Click **My Users**.
4. Click **Create**.
5. Name the user to identify it easily.
6. Enter your email address as the Reply Email and Notification Email Addresses.
7. Enter a unique username.
8. Leave the External ID field blank, unless required by your organization.
9. Set a Time Zone.
10. Set a Culture Code.
11. Select **API User**.
12. Create a temporary password.
13. If you are using a non-enterprise 2.0 account, set the following roles and permissions on this page:
 - User Permissions: NONE
 - Marketing Cloud Permissions and Roles: NONE
 - Select **Email Application**
 - Select **Mobile Connect** if applicable
 - Select **Marketing Cloud Administrator** role
14. Save the new Marketing Cloud API user.

If you are using an enterprise 2.0 account, continue to set roles and permissions.

15. Click **My Users** from Email Studio Admin.
16. Select the Marketing Cloud API User.
17. Click **Manage Roles**.
18. Click **Edit Roles**.
19. Assign the following roles:
 - Administrator
 - Marketing Cloud Administrator
20. Save the roles for the Marketing Cloud API user.

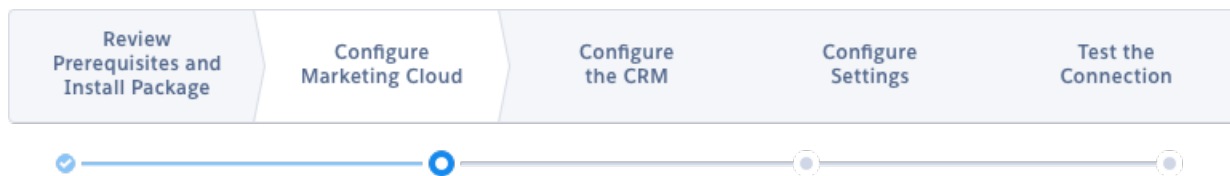

Connect Marketing Cloud API User in Marketing Cloud Connect

Connect the Marketing Cloud API user to the Salesforce system user to enable core system communication activities in Marketing Cloud Connect. These activities include pushing tracking data from the Marketing Cloud into your Sales or Service Clouds.

1. In the Marketing Cloud, navigate to **Email Studio**.
2. Click **Admin**.
3. Expand Account Settings and click **My Users**.
4. Select the API user.
5. Click **Integrate** for Salesforce.com Status.
6. Enter the Salesforce system user username.
7. Save the settings.
8. The Salesforce.com Status field updates to "Integrated" if the connection is successful.

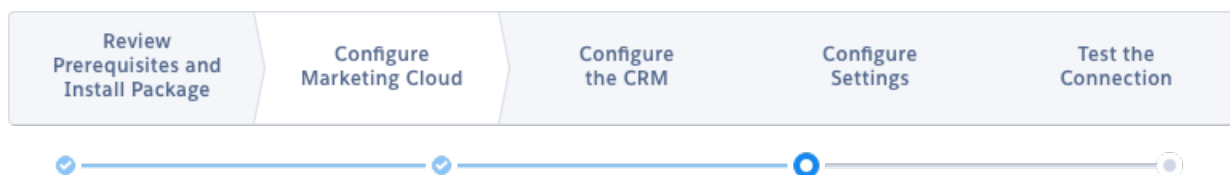

Assign Business Units

For Marketing Cloud Enterprise 2.0 accounts, assign applicable business units to the Marketing Cloud API user. The Marketing Cloud Connect API user's business unit access in Marketing Cloud determines which business units are available for use within Sales or Service Cloud.

 **Note:** If your Marketing Cloud account isn't Enterprise 2.0, proceed to the next topic. Not sure what type of account you have? Review Marketing Cloud editions to learn your account type or talk to your account representative.

1. In the Marketing Cloud, navigate to **Email Studio**.
2. Click **Admin**.
3. Click **My Users**.
4. Select the Marketing Cloud API User.
5. Click **Manage Business Units** at the top of the Users table.
6. Ensure that the selection under Default Business Unit is the top-level business unit.
7. In the Associated Business Units section, select all business units to be used with Marketing Cloud Connect.
8. Save the changes to the Marketing Cloud API User.

 **Note:** Repeat this process when creating business units in the future for use with Marketing Cloud Connect.

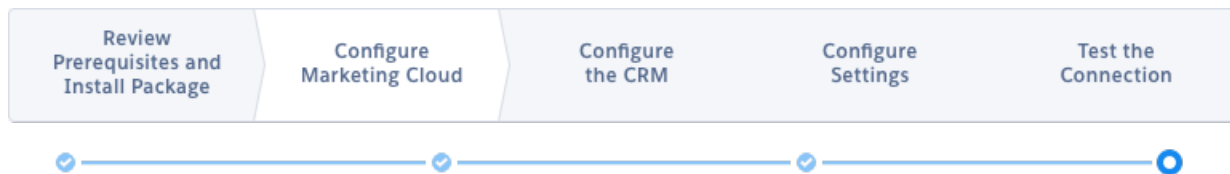

Set Up Authentication

Complete these tasks to set up connected app authentication for Marketing Cloud Connect.

This mechanism authenticates between Sales, Service, and Marketing Clouds without requiring you to store Sales or Service Cloud passwords in the Marketing Cloud. It also prevents SOAP and REST API calls made by Marketing Cloud Connect from counting against your rolling 24-hour limit.

1. In the Sales or Service cloud, click **Setup**.
2. Under Administer, click **Manage Apps**.
3. Click **Connected Apps**.
4. Click **Salesforce Marketing Cloud**.
5. Click **Edit Policies**.
6. Under Permitted Users, select **Admin approved users are pre-authorized**.
7. If a warning message appears, click **OK**.
8. Under IP Relaxation, select **Relax IP restrictions**.
9. Under Refresh Token Policy, select **Immediately expire refresh token**.

10. Save changes.
11. From Setup, click **Manage Users** under Administer.
12. Click **Permission Sets**.
13. Click **New**.
14. Give the permission set a memorable name. For example, Marketing Cloud Connected App.
15. Validate the generated API name and ensure that this field contains the desired value.
16. Save the permission set.

Apply the permission sets to the API User: Marketing Cloud Connected App, Marketing Cloud Connector, Marketing Cloud Connector Admin, and Marketing Cloud System User.
17. From Setup, click **Manage Users** under Administer.
18. Click **Permission Sets**.
19. Click the name of the newly created permission.
20. Click **Manage Assignments**.
21. Click **Add Assignments**.
22. Select the users who need access to the connected app, typically those users who access Marketing Cloud Connect.
23. Ensure that the Salesforce system user is selected for access.
24. Click **Assign**.
25. Click **Done**.
26. In the Sales or Service cloud, click **Setup**.
27. Under Administer, click **Manage Apps**.
28. Click **Connected Apps**.
29. Click **Salesforce Marketing Cloud**.
30. Click **Manage Permission Sets**.
31. Select the newly created permission set.
32. Save changes.

 **Warning:** During this process, the system automatically connects to any active Marketing Cloud session to establish the Marketing Cloud Connect API user. To prevent an incorrect connection, log out of any active Marketing Cloud sessions; closing the tab does not end an active session
33. In Sales or Service Cloud, navigate to the **Marketing Cloud** tab.

If you are working with Salesforce Support and using a Marketing Cloud Production Support environment, click **Advanced Settings** and select **Sandbox** from the Marketing Cloud Environment list.
34. Click **Connect to Marketing Cloud**.
35. Enter the username and password for the Marketing Cloud Connect API User.
36. Click **Login**.



Designate Default Workflow User

Complete the steps for designating a default workflow user as part of the CRM configuration of Marketing Cloud Connect.

The default workflow user is required for time-dependent workflows used by Marketing Cloud Connect. This username is displayed when the user who triggered the rule isn't active.

 **Note:** Skip this task if you already use time-dependent workflows and a default workflow user is already designated in your Salesforce org.

1. In Sales or Service Cloud, click **Setup**.
2. Under Build, click **Create**.
3. Click **Workflow & Approvals**.
4. Click **Process Automation Settings**.
5. Designate the default workflow user using Lookup to choose the applicable user.
6. Save the default workflow user.



Update Field-Level Security

Change field-level security making the email opt-out field visible on leads and contacts, which is a requirement for sending Marketing Cloud emails through Marketing Cloud Connect.

1. In Sales or Service Cloud, navigate to **Setup**.
2. Click **Customize** under Build.
3. Click **Contacts**.
4. Click **Fields**.
5. Click **Email Opt Out**.
6. Click **Set Field-Level Security**.
7. Enable Visibility for all applicable profiles.
8. Save.

9. Click **Customize** under Build in the Setup menu.
10. Click **Leads**.
11. Click **Fields**.
12. Click **Email Opt Out**.
13. Click **Set Field-Level Security**.
14. Enable Visibility for all applicable profiles.
15. Save.



Update Page Layouts

Add email and mobile send tracking to contact and lead pages to continue configuration of Sales and Service Cloud for Marketing Cloud Connect.

The Sales or Service Cloud admin performs this task to update the page layouts for contacts and leads to include Marketing Cloud Connect functionality.

1. In the Sales or Service Cloud, navigate to **Setup**.
2. Click **Customize** under Build.
3. Click **Contacts**.
4. Click **Page Layouts**.
5. Select applicable page layout.
6. Add **ContactActions** from the Visualforce Pages section.
7. Add **Email Sends** from the Related Lists section.
8. Add **Individual Email Results** from the Related Lists section.
9. Save and do not close the tab.
10. Click **Yes** if prompted to overwrite users' related list customizations.
11. In the Setup menu, click **Customize** under Build.
12. Click **Leads**.
13. Click **Page Layouts**.
14. Add **LeadActions** from the Visualforce Pages section.
15. Add **Email Sends** from the Related Lists section.
16. Add **Individual Email Results** from the Related Lists section.
17. Save and do not close the tab.
18. Click **Yes** if prompted to overwrite users' related list customizations.

19. Repeat these steps as necessary for desired page layouts.

 **Note:** The Marketing Cloud Connect managed package includes the following page layout elements that are no longer needed and can be deleted if desired.

- @deprecated / et4ae5.Default_MID
- @deprecated / et4ae5.ExactTarget_OAuth_Token
- Default Marketing Cloud Page / et4ae5.Default_ET_Page
- Marketing Cloud Username / et4ae5.ExactTargetUsername
- Valid Marketing Cloud Admin / et4ae5.ExactTargetAdmin
- Valid Marketing Cloud User / et4ae5.ExactTargetUser



Launch the Setup Wizard

To configure Marketing Cloud Connect in Sales or Service Cloud, launch the setup wizard in Salesforce Classic UI.

This process launches the setup wizard to automatically add required IP addresses to the allowlist, create required workflows, and set up new permission sets.

 **Important:** Lightning Experience doesn't support the setup wizard.

 **Note:** Custom domains aren't required to use the setup wizard. However, if you don't use the setup wizard, manually add IP Addresses to the allowlist and create workflows.

1. In the Sales or Service Cloud Setup menu, click **Security Controls** under Administer.
2. Click **Session Settings**.
3. Save without changing anything.
4. In the Sales or Service Cloud, navigate to the **Marketing Cloud** tab.
5. Agree to verify the Metadata API remote site.
6. Start the automatic setup wizard.
7. Ensure that you completed the pre-install tasks.
8. Agree to the terms.
9. To run the setup wizard, click **Configure Marketing Cloud Connect**.
10. Click **Okay** when the wizard is complete.

If you couldn't automatically verify the Metadata API remote site, follow these steps to install the remote site manually.
11. In the Sales or Service Cloud Setup menu, click **Security Controls** under Administer.
12. Click **Remote Site Settings**.

13. Click **New Remote Site**.
14. Edit the new remote site with the following information:
 - Remote Site Name: MetadataAPI
 - Remote Site URL: https://{domain}.salesforce.com
 - Description: Remote site setting to make callouts
15. Save the remote site.



Connect to Marketing Cloud

The Sales or Service Cloud admin connects the Sales or Service Cloud account with the Marketing Cloud account using the Marketing Cloud API user credentials. This task completes the account-level connection for Marketing Cloud Connect.

1. In the Sales or Service Cloud, navigate to the **Marketing Cloud** tab.
2. Click **Show Advanced Settings**.
3. Enable Tenant-Specific OAuth Endpoints.

 **Note:** When you enable Tenant-Specific OAuth Endpoints, your Marketing Cloud Connector Settings are removed. If you are reintegrating, record your settings before enablement.

4. Enter the Marketing Cloud API user credentials.
5. To connect the accounts, click **Connect**.

You can now manage Marketing Cloud Connect settings and test the connection to complete the setup.



Manage Marketing Cloud Connect Settings

Admins access Marketing Cloud Connect settings and send configuration by navigating to the Marketing Cloud object in the Sales or Service Cloud. Admins can configure these settings, including sends, tracking, users, and business units, after the installation and setup process to enable sending through Marketing Cloud Connect. Edit settings anytime.

Field	Description
Username	The username of the Marketing Cloud API user that connects the accounts.
Marketing Cloud Type	Marketing Cloud edition type.
Send Types	Type of sends available for use through Marketing Cloud Connect. Email must be selected to ensure that sends are enabled for users.
Alternate 'Reply-to' Options	Allows you to select from a configurable list of names and email addresses to have replies sent. Reply Mail Management must be enabled and configured in Marketing Cloud for Reply-To Options to work.
Marketing Cloud Deep Link Access	These Edit, New Email, and Go To Marketing Cloud links automatically log in users to Marketing Cloud to perform those functions. Use this configuration setting to restrict the use of these deep links within the Marketing Cloud Connect installation.
Target Audience	Recipient type that can be selected for sending. Select Report and Campaign to enable sending through Marketing Cloud Connect. Only active campaigns are sendable. With scope by user configuration, you need access to folders containing the desired report to send to them.
Exclusion Audience	Audience type that can be excluded from targeted audiences.
Retry Failed Sends	If this option is selected, the system retries sending if the system is temporarily unavailable. The option to cancel a send is provided to prevent it from being retried. Retry is only available when a support ticket recipient has been added to this settings page.
My Personal Custom Reports	Enabling this option allows sending to reports saved in My Personal Custom Reports folder. This option is available for scope by user account configuration only, as system admins don't have access to this folder.
Restriction	Select the desired restriction level of Marketing Cloud Connect triggered sends to only admins or admins and users. This restriction applies only to the administration of triggered sends, not sending them.
Enabled Objects	Set the list of objects that triggered sends can be created for within Marketing Cloud Connect.
Support Ticket Recipient	Set an email address of the Salesforce support resource in your company who gets notifications of issues or problems with Marketing Cloud Connect.
Logging	Selecting this option starts logging all package-related API calls and associated details. Logging is disabled 60 minutes after it's enabled. After logging is enabled, the Initiate Logging button

Field	Description
	changes to a hyperlink that links to the Documents object. From Documents, select Marketing Cloud Documents.
Tracking Detail	Select the desired level of tracking data to return to the Sales or Service Cloud from the Marketing Cloud.
Tracking Frequency	Set the desired frequency for tracking data to be updated. We recommend hourly.
Number of Days Tracked	Set the number of days that tracking data is returned to the Sales or Service Cloud after the send, up to 365 days. Tracking data is retained in Salesforce after this time period has expired. We recommend 90 days.
Campaign Member Tracking	Allows for setting campaign member status based on tracking data.
(Advanced setting) Tenant-Specific OAuth Endpoints	Enable tenant-specific OAuth endpoints or remove to use generic endpoints. Use these endpoints to enable security interactions for your integration and protect against service disruptions in authentication.

Business Unit Management

Marketing Cloud Connect admins follow these steps to map business units from Marketing Cloud Enterprise 2.0 accounts across clouds to enable them in Marketing Cloud Connect. Not sure what type of account you have? Review Marketing Cloud editions for more information.

 **Note:** Before installation and configuration, confirm that the Marketing Cloud API user can access the following items:



- Top-level default parent business unit.
- All business units that are enabled for sends through Marketing Cloud Connect.

1. In Sales or Service Cloud, navigate to the **Marketing Cloud** tab.
2. Click **Configure Marketing Cloud Connector**.
3. Click **Manage Business Units**.
4. Select business units to enable.
5. Save the selections.

 **Note:** This page only supports 4,000 business units. If you have more than 4,000, create a business unit tab as a custom solution to accommodate more. You can use a single integration user for a maximum of five business units.

Map Attribute Fields

To personalize communications, map Sales Cloud Contact, Lead, and Account objects within the Marketing Cloud to share attributes across the clouds and enable personalization for Marketing Cloud Connect communications. Multi-org doesn't support Web Collect or custom field and attribute mapping.

1. In Marketing Cloud, navigate to **Email Studio**.
2. Click **Subscribers**.
3. Click **Profile Management**.
4. Select an existing attribute or create one.
5. In the New Attribute Properties window, click the **Salesforce** tab within the attribute properties.
 -  **Note:** The Salesforce tab is only available if you already connected your Marketing Cloud account with your Sales or Service Cloud org through Marketing Cloud Connect.
6. To map the attribute, select the field.
 -  **Note:** The maximum length of the Profile Attribute must match the maximum length of the Salesforce object. Mismatched lengths can cause errors with a triggered send or a Journey Builder send.
7. Repeat to map each attribute to a field in the Sales or Service Cloud.

Test the Connection in Marketing Cloud Connect

Complete these steps to ensure Marketing Cloud Connect is set up properly for sending. Create an email in Marketing. Next, create a lead and report for this test. Send the email from the Email Sends object in Sales Cloud, using the lead and report you created. Verify that the test completed.

[Map field attributes](#) on page 24 in Marketing Cloud and ensure that you configured Marketing Cloud Connect settings before completing this test.

1. To create an email for this test, navigate to **Email Studio** in Marketing Cloud.
2. Click **Content** and create an email. For example:



```
Sent to: %%emailaddr%% <br> JobID: %%jobid%% <br> <table cellpadding="2"
cellspacing="0" width="600" ID="Table5" Border=0><tr><td><font face="verdana" size="1"
color="#444444">This email was sent by: <b>%%Member_Busname%%</b><br>%%Member_Addr%%
%%Member_City%%, %%Member_State%%, %%Member_PostalCode%%,
%%Member_Country%%<br><br></font></td></tr></table> %%jobid%%<br><br> <a
href="%%unsub_center_url%%" alias="Unsubscribe">Unsubscribe</a> <custom
name="opencounter" type="tracking">
```
3. Select the **Text Only** option.
4. Name the email and click **Next**.
5. Enter a subject line, for example, *Integration Test*.
6. To test field mapping and personalization, enter the profile attributes that you mapped and System Attributes.
7. Select these System Snippets: **Physical Mailing Address (Required)**, **Profile Center (Required)**, and **Forward to a Friend**.
8. Save the email.
9. To create a lead and report for this test, navigate to the **Leads** object in Sales Cloud.
10. Create a lead with your name, email address, and ZIP code.
11. Navigate to the **Reports** object.
12. Create a report that displays only your lead record. Include Contact or Lead ID in the report. For example, create a Lead Report where Last Name = your last name and ZIP code = your ZIP code.

13. Save the report to the Marketing Cloud Admin report folder.
14. If your account is configured for non-scope by user, filter the report to show all leads.
15. To test the connection by sending an email, navigate to the **Marketing Cloud** object
16. To select the email you created for this test, click **Find**.
17. Select **Report** for Recipients and search for the report you created for this test.
18. Select your email address for the From email address list.
19. Certify that all of these people have opted in.
20. Send the email.
21. To verify the test in the Sales Cloud, navigate to the **Email Sends** object.

 **Note:** The test send can take up to 60 minutes to complete.

22. Click the Email Send Number in the Recently Viewed list that corresponds with the test send.
23. To confirm that send was completed, check the status of the email.
24. Check the test email that you received to ensure the personalization populated correctly.

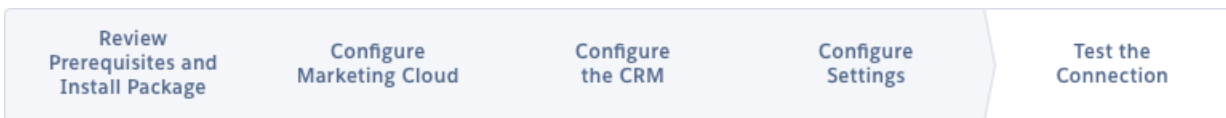
Previous Topic: [Configure Settings](#)



Manage Users

After completing the Marketing Cloud Connect installation and setup, integrate Marketing Cloud and Sales or Service Cloud users to enable access to Marketing Cloud Connect.

 **Note:** Marketing Cloud Connect users need a license for the Marketing Cloud and a license for Salesforce CRM to use most Marketing Cloud Connect functionality.

Enterprise 2.0 Marketing Cloud Accounts

The Marketing Cloud admin follows this process to set up users in Enterprise 2.0 Marketing Cloud accounts for Marketing Cloud Connect.

1. In Marketing Cloud, navigate to **Email Studio**.
2. Click **Admin**.
3. Click **My Users**.
4. Select the user to connect.
5. Click **Integrate** for Salesforce.com Status.
6. Enter Sales or Service Cloud username.
7. Save settings.
8. From My Users, select the user.

9. Click **Manage Roles**.
10. Select the applicable business unit.
11. Click **Edit Roles**.
12. Select the following minimum permissions required for sending through Marketing Cloud Connect:

- **Content Creator**
- **Data Manager**
- **Marketing Cloud Content Editor/Publisher**

 **Note:** You can also allow Email > Integrations permissions for any users that need to send from your connected Salesforce org.

13. Save the roles.

All Other Marketing Cloud Accounts

The Marketing Cloud admin follows this process to set up users in all non-Enterprise 2.0 Marketing Cloud accounts for Marketing Cloud Connect.

1. In Marketing Cloud, navigate to **Email Studio**.
2. Click **Admin**.
3. Click **Account Settings**.
4. Click **My Users**.
5. Click the applicable user.
6. Click **Integrate** for Salesforce.com Status.
7. Enter Sales or Service Cloud username.
8. Save settings.
9. Click **Edit**.
10. Select **Enabled**.
11. Select **API User**.
12. Under User Permissions, select the following minimum permissions:
 - **Grant the user access to the web services**
 - **Administrative Data Management**
 - **Manage Data Extension Data and Retention Policy**
13. Under Marketing Cloud Permissions and Roles, select **Email** for applications.
14. Under Marketing Cloud Permissions and Roles, select **Marketing Cloud Content Editor/Publisher** or **Administrator** for roles.
15. Save the user changes.
16. Repeat this process for all integration users.

Integrate Users with Marketing Cloud

The Marketing Cloud Connect admin finishes the user setup process in Marketing Cloud Connect.

1. In Sales or Service Cloud, navigate to the **Marketing Cloud** tab.

2. Click **Configure Marketing Cloud Connector**.
3. Click **Manage Users**.
4. Select each applicable user.
5. To complete setup of Marketing Cloud Connect users, save changes.

MARKETING CLOUD CONNECT USE CASES

Learn about how you can use Marketing Cloud Connect features after completing setup. Follow steps to configure a multi-org setup, send emails, configure triggered sends, configure Synchronized Data Sources, and integrate with Journey Builder.

[Multi-Org Account Configuration in Marketing Cloud Connect](#)

Multi-Org is an Enterprise 2.0 account configuration. This configuration allows individual Marketing Cloud business units to connect with a single Salesforce org, independent of the parent account or other business units. Using Marketing Cloud Connect, this configuration includes two setup scenarios:

[Email Sends](#)

Integrated users send Marketing Cloud emails through the Sales or Service Cloud with Marketing Cloud Connect. Send single emails to leads, contacts, and person account records, or send to a list through campaigns and reports.

[Salesforce Data Extensions in Marketing Cloud Connect](#)

A data extension is a table that contains your data. With Marketing Cloud Connect, push tracking data from the Marketing Cloud back to your Sales or Service Cloud orgs using Salesforce data extensions (SFDEs). Push any tracking data for emails sent to SFDE audiences using Marketing Cloud Salesforce Sends to the Salesforce Contact or Lead record in the connected org. SFDEs can use the same Marketing Cloud segmentation and filtering tools as standard data extensions. Data extensions created from sends to reports or campaigns have a hard-coded retention policy of five days.

[Triggered Sends](#)

Use triggered email sends to create and send automated messages to Salesforce contacts, leads, or person accounts when object records are created or updated.

[Synchronized Data Sources in Contact Builder](#)

Synchronized Data Sources in Contact Builder bring data from across the Salesforce Customer Success Platform into your Marketing Cloud account. Synchronized Data Sources synchronize data from your Salesforce account at prespecified time intervals, including data schema and relationships previously established in your Salesforce CRM account.

[Journey Builder Integration](#)

Journey Builder is a Marketing Cloud application used for creating responsive automated multi-channel campaigns. Use Journey Builder to design a communication plan that reaches customers at every stage of their journey with your brand. Configure Marketing Cloud Connect in your org to access specific Journey Builder features within the Sales or Service Clouds. For example, add a lead, contact, or a user to a journey, or update a Salesforce object as a step in the journey.

Multi-Org Account Configuration in Marketing Cloud Connect

Multi-Org is an Enterprise 2.0 account configuration. This configuration allows individual Marketing Cloud business units to connect with a single Salesforce org, independent of the parent account or other business units. Using Marketing Cloud Connect, this configuration includes two setup scenarios:

- Multiple business units connected to multiple orgs.



Note: We support up to 5 business units to the same tracking user in a multi-org environment. If you use more than 5 business units, service can be degraded and can negatively impact the servers.

- Multiple business units connected to a single org.

 **Note:** Multi-Org is available for Enterprise 2.0 accounts using version 5.494 or higher of the managed package. It requires Connected App Authentication and Custom Profile Centers. Not sure what type of account you have? Review Marketing Cloud editions for more information.

These best practices are recommended when configuring multi-org.

- Control access to All Subscribers list.

The Marketing Cloud All Subscribers list is a comprehensive list of all subscribers, even in a multi-org account. To prevent users from seeing subscribers outside of an org they can access, remove non-admin users' access to All Subscribers and use Subscriber Business Unit Filters.

- Plan your business unit and user connections.

While disconnecting accounts is supported, plan your Salesforce org to Marketing Cloud business unit and user connections carefully before implementation.

- Use dedicated API users.

Assign each connected business unit a dedicated API user to reduce confusion after connecting. If multiple business units are connected to the same Salesforce org, use a shared API User.

- Use one version of the connector.

When connecting your Marketing Cloud account with multiple orgs, use the same version of the connector in each connected org. For example, don't use V2 in one Salesforce org and Marketing Cloud Connect (V5) in another Salesforce org.

 **Warning:** If you use Synchronized Data Sources with multi-org configuration, when you disconnect a business unit from Sales or Service Cloud, synchronized data extension names can change. To ensure that they continue working, update query activities that reference those synchronized data extensions.

[Multi-Org Account and User Configuration](#)

Through Marketing Cloud Connect, multi-org supports connections for one Marketing Cloud business unit to one Sales or Service Cloud org. Multi-org also supports many Marketing Cloud business units to one Sales or Service Cloud org. Multi-org doesn't support connections for a single business unit to multiple Sales or Service Cloud orgs, or business units of multiple Enterprise 2.0 accounts to the same org. Multi-org supports various user mappings based on these business unit configurations.

[Multi-Org FAQs](#)

Answers to your questions about Marketing Cloud Connect multi-org configuration.

[Upgrade to a Multi-Org Account](#)

With Marketing Cloud Connect, multi-org accounts offer flexibility, but upgrading impacts the underlying structure of your Enterprise 2.0 account. Before upgrading, review these considerations for compatibility:

Multi-Org Account and User Configuration

Through Marketing Cloud Connect, multi-org supports connections for one Marketing Cloud business unit to one Sales or Service Cloud org. Multi-org also supports many Marketing Cloud business units to one Sales or Service Cloud org. Multi-org doesn't support connections for a single business unit to multiple Sales or Service Cloud orgs, or business units of multiple Enterprise 2.0 accounts to the same org. Multi-org supports various user mappings based on these business unit configurations.

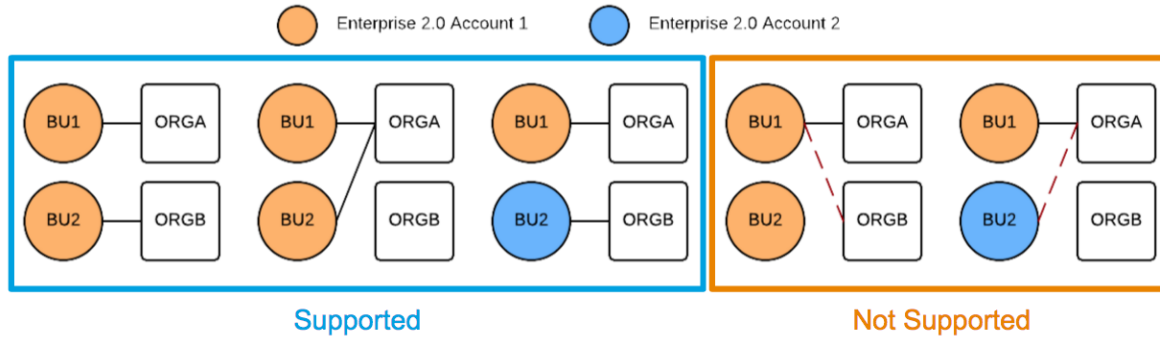

Multi-Org User Configurations

A single Marketing Cloud user can access multiple Marketing Cloud business units. Business unit access determines the ability to access multiple orgs.

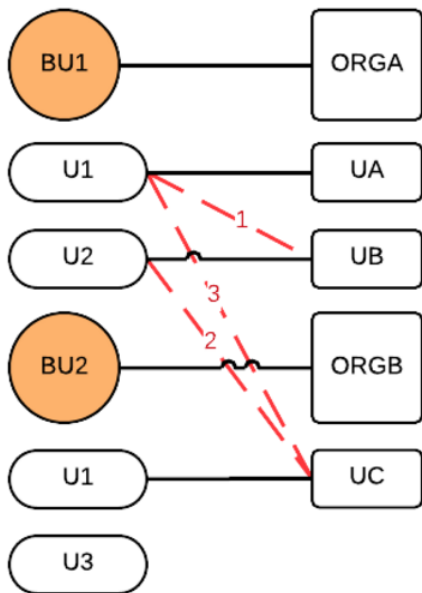

- You can map a single Marketing Cloud user to multiple Sales or Service Cloud users if the Sales or Service Cloud users are in different orgs and the Marketing Cloud user has access to the connected business units. In this example, although user, U1, is already mapped to UA in ORGA, U1 can also map to UC in ORGB since U1 has access to both business units and UA and UC are in different Orgs.
- You can't map a single Marketing Cloud user to more than one Sales or Service Cloud user within one org. In this example, U1 is mapped to UA and can't be mapped to any other user in the same org, shown by broken line 1.
- You can't map a Marketing Cloud user to a Sales or Service Cloud user if that org is connected to a business unit that the Marketing Cloud user can't access. In this example, U2 does not have access to BU2, so U2 can't map to UC, shown by broken line 2.
- You can map users to multiple orgs through multiple business units. However, users access only the org that is connected to the business unit the user is logged in to. In this example, U1 can access BU1 and BU2, but can't map to UC while logged in to BU1, shown by broken line 3. U1 must log in to BU2 to connect to UC.

- An unconnected Marketing Cloud user accesses the Marketing Cloud only. In this example, U3 can't access Sales or Service Cloud orgs.

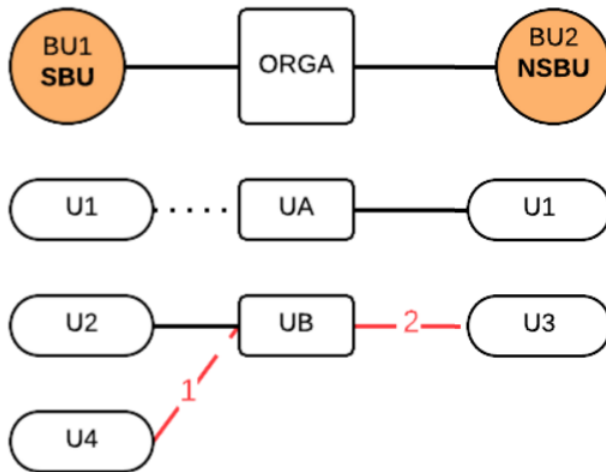

- You can map a Marketing Cloud user to the same Sales or Service Cloud user if the Marketing Cloud user can access multiple connected business units. In this example, user U1 accesses multiple business units in the same Enterprise 2.0 account. These business units are connected to the same Sales or Service Cloud org. U1 can connect to the same Sales or Service Cloud user, UA, through either business unit.
- You can't map multiple Marketing Cloud users to the same Sales or Service Cloud user. In this example, U2 is connected to UB, so U3 and U4 can't connect to UB.

Multi-Org FAQs

Answers to your questions about Marketing Cloud Connect multi-org configuration.

Is Multi-Org Enabled by Default?

No. Multi-Org must be requested from Support. We examine your account to ensure that Multi-Org is right for you.

Who Can Upgrade to a Multi-Org Account?

Multi-Org is an Enterprise 2.0 account configuration. It requires version 5.494 or higher of Marketing Cloud Connect and Connected App Authentication.

What Are the Benefits of Multi-Org?

Multi-Org connects multiple Salesforce orgs to a single Enterprise 2.0 account, with all the Enterprise 2.0 account benefits. Your Sales or Service Cloud connections are managed at the Business Unit level. Multi-Org is a great solution to centralize your marketing content in Marketing Cloud, but maintain separate CRM data throughout your organization.

Why Upgrade to Multi-Org?

Customers with multiple Sales or Service Cloud instances that hold different data or serve different business functions can typically benefit from upgrading.

Can I Enable Multi-Org for an Existing Account?

Yes. Upgrading an existing Enterprise 2.0 account is possible, but any previously connected business unit must be manually reconnected. The top-level (parent) account remains connected.

Example: I have a standard Enterprise 2.0 Marketing Cloud account with five Business Units connected to a single Sales Cloud org. The top-level (parent) account is connected to the same org. In a non-Multi-Org account, all five Business Units could inherit the parent-level connection. Enabling Multi-Org removes the Business Unit connections inheritance, breaking any existing Business Unit connection. The top-level (parent) account remains connected. Each Business Unit must be individually reconnected to the appropriate Sales Cloud org after upgrading. Also, reconnect user mappings at the Business Unit level.

Does Multi-Org Require a New or Separate Installation of Marketing Cloud Connect?

No. Multi-Org is available for any existing Marketing Cloud Connect customers using version 5.494 or higher. When Multi-Org is enabled, your accounts are disconnected. Disconnecting your account removes existing user mappings, attribute mappings, and tracking subscriptions.

Can I Disable Multi-Org?

No. After your account is upgraded to Multi-Org, you can't turn it off.

How Do I Get Multi-Org Improvements?

All Multi-Org improvements and enhancements are automatically pushed to your account with every Marketing Cloud release.

What Are Multi-Org Best Practices?

We recommend controlling All Subscriber List access, using a custom profile center, and carefully planning your account and user setup. Review [Multi-Org Account Configuration](#) on page 29.

Do Child Business Units Inherit Parent Mappings?

No. Parent-mapping inheritance isn't currently supported. All connections must be managed at the Business Unit level. While upgrading, suspend all sending through Marketing Cloud Connect as any in-flight sends fail.

Are There Restrictions When Connecting Users?

Yes. Establish a one-to-one connection between Sales and Marketing Cloud customers. However, more complex connection schemes are supported depending on your business unit connections.

Can I Disconnect My Accounts?

Yes. You can disconnect any Business Unit from your Sales or Service Cloud using the Salesforce Integration screen in the Marketing Cloud. Disconnecting your account removes existing user mappings, attribute mappings, and tracking subscriptions. After it is disconnected, that Business Unit can connect to any eligible org.



Warning: If you use Synchronized Data Sources with multi-org configuration, when you disconnect a business unit from Sales or Service Cloud, synchronized data extension names can change. To ensure that they continue working, update query activities that reference those synchronized data extensions.

Are There Best Practices for Reconnecting?

Yes. If you're disconnecting and reconnecting to a different Salesforce org, click **Disconnect** in Marketing Cloud Connect settings before reconnecting. Pause any Synchronized Data Sources during the process.

Is Sharing Salesforce Data Extensions (SFDEs) Across Business Units (BUs) Allowed?

No. Sharing SFDEs in a Multi-Org account isn't supported, even between BUs connected to the same org. Sharing standard Data Extensions and content is supported. Review and move data extensions under the Shared Salesforce Data Extensions folder. Access is removed when multi-org is enabled.

Is Personalization Supported in Multi-Org?

Yes, for standard fields only. Using custom fields from the Sales Cloud requires AMPscript.

Is the Standard Profile Center Supported in Multi-Org?

No. Custom Profile Centers are required for Multi-Org.

Is Web Collect Supported?

No.

Is One Custom Profile Center (CPC) Per Business Unit Required?

No. One CPC per Business Unit is an option, but isn't required. Other options include one CPC that manages business unit unsubscribes, or multiple CPCs that align with key departments, publications, or verticals in your business. It's important that you manage unsubscribes to remain CAN-SPAM compliant.

Can I Use Multi-Org with My Sandbox and Production Accounts?

Yes, but consider the following:

- Sandbox promotions aren't possible in Marketing Cloud. Org sandboxes can be promoted into production orgs. You can't promote changes in a 'test' business unit into another 'prod' business unit.
- Sandboxes are often used for testing items that are high risk for adversely affecting accounts, such as load tests, performance tests, or volume tests. Connecting your production account to your sandbox org elevates the risk of harming your production account.
- Marketing Cloud business units aren't data-isolated. Test data and production data are co-mingled when using a sandbox, which impacts data cleanliness and adds complexity to reporting, audience creation, and so on.

- All business units receive code at the same time. You can test Sales or Service Cloud changes before the release. However, Marketing Cloud changes go live at the same time, regardless of whether the business unit is tied to a Sandbox.

Do Deep Links Work with Multi-Org Accounts?

Yes, but consider the following. When using deep links with multi-org accounts, you're logged in to your default Marketing Cloud business unit. This login is regardless of whether that business unit is configured for use with the Sales or Service Cloud by Marketing Cloud Connect. To access a business unit other than your default, log directly in to the desired Marketing Cloud business. To avoid changing in the incorrect business unit, avoid using deep links.

Upgrade to a Multi-Org Account

With Marketing Cloud Connect, multi-org accounts offer flexibility, but upgrading impacts the underlying structure of your Enterprise 2.0 account. Before upgrading, review these considerations for compatibility:

- Enterprise 2.0 Marketing Cloud account with multi-org is enabled.
- Connected App authentication is installed.
- Marketing Cloud Connect managed package version 5.494 or higher is installed.
- Your Marketing Cloud Admin configures your custom profile.
- Multiple Sales or Service Cloud orgs exist.
- Licenses are available for Marketing Cloud API user and Salesforce system users.
- Multi-org doesn't support custom fields in webcollect, which means, if the form contains custom fields, we can't collect the data supplied by the subscribers.

After ensuring your account meets the requirements for compatibility, follow these steps to upgrade. The upgrade requires a minimum of two hours.

1. Log a support ticket in Salesforce Help for the upgrade.
2. Pause all Marketing Cloud email sends through the Sales or Service Cloud until the upgrade completes.
3. If you use Synchronized Data Sources, pause data synchronization across clouds until the upgrade completes.

 **Important:** When using multi-org with Synchronized Data Sources, ensure that the tracking user is connected to less than five business units.

4. To improve performance, after you upgrade to multi-org in an existing account, reconnect previously connected business units.

 **Important:** You can't turn off multi-org after it's turned on.

Email Sends

Integrated users send Marketing Cloud emails through the Sales or Service Cloud with Marketing Cloud Connect. Send single emails to leads, contacts, and person account records, or send to a list through campaigns and reports.

Send from Sales or Service Clouds

Send emails from any of the following:

- Running User: the person currently logged in to Salesforce.
- Record Owner: the user who created the record as the sender.

- Org-wide Email Address: a list of users in the Sales or Service Cloud whose email address qualifies as a possible sender.
- Send Classification: uses the sender profile associated with it.

 **Note:** Ensure that all default sender profiles, delivery profiles and send classifications aren't deleted or renamed. Marketing Cloud Connect must recognize Default Commercial and Default Transactional send classifications.

The first time a message is sent through Marketing Cloud Connect to a contact, lead, or person account from Sales or Service Cloud, that recipient is added to the All Subscribers list in Marketing Cloud. For example, when a Marketing Cloud email is sent from the Sales Cloud to a report containing contacts, those contacts are added to the All Subscribers list. The Marketing Cloud status for that subscriber is set to Active in the All Subscribers list.

Also, the first time a message is sent through Marketing Cloud Connect to a contact, lead, or person account from Sales or Service Cloud, a unique Marketing Cloud subscriber key is created to identify that individual based on the LeadID or ContactID fields. Email tracking history, email opt-out, and preferences for that individual are tied to the subscriber key. If you use a lead conversion process to convert leads to contacts in Sales Cloud, when the ContactID is sent to Marketing Cloud a new subscriber is added with a new subscriber key. Therefore, the tracking data, opt-out, and preferences are not automatically transferred for that individual.

Send from Marketing Cloud

Marketing Cloud classic emails and Content Builder emails can also be sent to Salesforce reports, campaigns, and data extensions directly in Marketing Cloud Email Studio.

After your Marketing Cloud and Sales or Service Cloud user accounts are integrated, reports, campaigns, and Salesforce data extension are available recipient options. Use one of these methods to send:

- Complete a Guided Send for classic emails
- Complete a Send Flow for Content Builder emails
- Select Salesforce Send Emails under Interactions for both classic emails and Content Builder

 **Note:** Not seeing this functionality? It's available after users are connected to the CRM on their User Detail record. Salesforce.com Status is **Integrated**.

[Send Single Email with Marketing Cloud Connect](#)

Follow these steps to send a single Marketing Cloud email from within Sales or Service Cloud through Marketing Cloud Connect.

[Send to Campaigns or Reports](#)

Send a Marketing Cloud email from within Sales or Service Cloud to a campaign or report through Marketing Cloud Connect. Reports must contain Contact ID, ContactID, Lead ID, or LeadID fields. Store reports in a custom Salesforce folder for sending and ensure that the user who executes the send can access the folder. Marketing Cloud Connect doesn't support sending to joined reports or reports stored in standard Salesforce folders.

[Marketing Cloud Sends to Campaigns or Reports](#)

Use this Marketing Cloud Connect feature to create a Salesforce Send Definition and send to Salesforce campaigns or reports in the Marketing Cloud. Reports must contain Contact ID, ContactID, Lead ID, or LeadID fields. Store reports in a custom Salesforce folder for sending and ensure that the user who executes the send can access the folder. Marketing Cloud Connect doesn't support sending to joined reports or reports stored in standard Salesforce folders.

Send Single Email with Marketing Cloud Connect

Follow these steps to send a single Marketing Cloud email from within Sales or Service Cloud through Marketing Cloud Connect.

1. In Sales or Service Cloud, navigate to a lead, contact, person account, or campaign.

2. Click **Send Marketing Cloud Email**.

3. To access Marketing Cloud emails, click **Find**.

4. Select an email.

5. Select a From email address.

6. Select a Reply-to email address.

 **Note:** Ensure that Reply Mail Management is configured for your account.

7. Select **Disable Individual Level Tracking** if you want to prevent subscriber level tracking from being created for the send.

8. Set the time and date for sending.

 **Note:** This setting determines the date and time the process starts, not the actual date and time the email is sent. You can update and cancel a scheduled send.

9. Verify that you have permission to send an email to the recipient.

10. Send the email.

Send to Campaigns or Reports

Send a Marketing Cloud email from within Sales or Service Cloud to a campaign or report through Marketing Cloud Connect. Reports must contain Contact ID, ContactID, Lead ID, or LeadID fields. Store reports in a custom Salesforce folder for sending and ensure that the user who executes the send can access the folder. Marketing Cloud Connect doesn't support sending to joined reports or reports stored in standard Salesforce folders.

 **Note:** When you send to a report or campaign, Marketing Cloud Connect creates a data extension for the send. The data extension is automatically deleted after five days.

1. In Sales or Service Cloud, navigate to the **Marketing Cloud** tab.

2. If not automatically redirected, click **Email Send**.

3. If using an Enterprise 2.0 account, use the look-up tool to select a business unit from which the email send originates.

4. To select a Marketing Cloud email, click **Find**.

5. To see the email before sending, click **Preview Email**.

6. Edit the subject line if needed.

7. Add up to 10 reports or campaigns to **Recipients**.

8. If needed, add reports or campaigns to the **Exclusions** field to exclude recipients from the send.

9. To create an email linkage, select **Remember recipients and exclusions for this email**. This selection associates an email to this specific list of recipients and exclusions. On subsequent sends, selecting this email automatically populates the Recipients and Exclusions fields with the reports or campaigns chosen here.

10. Select a From email address or send classification.

 **Note:** If a contact has the Email Opt Out flag set, they don't receive Marketing Cloud emails, unless it is a transactional send classification. Version 5.18 or later of Marketing Cloud Connect is required for the transactional send classification.

11. Choose the **Reply-to** email address, used for receiving replies to this email.

12. To prevent sending more than one email to the same email address in this send, select **Dedupe Subscribers**.

13. To prevent subscriber level tracking for this send, select **Disable Individual Tracking**.

14. Set the **Send Date and Time** for the email send process to start.

 **Note:** Update or cancel a scheduled send as needed.

15. Certify that all recipients have opted in and provided permission to receive the email.

16. Send the email.

Marketing Cloud Sends to Campaigns or Reports

Use this Marketing Cloud Connect feature to create a Salesforce Send Definition and send to Salesforce campaigns or reports in the Marketing Cloud. Reports must contain Contact ID, ContactID, Lead ID, or LeadID fields. Store reports in a custom Salesforce folder for sending and ensure that the user who executes the send can access the folder. Marketing Cloud Connect doesn't support sending to joined reports or reports stored in standard Salesforce folders.

 **Note:** Send to up to 10 Salesforce campaigns or reports in the Marketing Cloud.

1. In Marketing Cloud, navigate to **Email Studio**.
2. Click **Salesforce Send Emails** under Interactions.
3. Click **Create**.
4. Enter a name and description for the email.
5. Select an email to send.
6. Select a send classification.
7. Click **Edit Recipients**.
8. Add Salesforce reports, campaigns, or data extensions to the **Targeted** recipient list.
9. Select a report, campaign, or data extension from the lookup window.

 **Tip:** To return all reports or campaigns, leave the search field blank and click **Find Now**.

10. Add Salesforce reports, campaigns, or data extensions to the **Exclusions** list if needed.
11. Save the recipients list.
12. Save the Salesforce send definition.
The Salesforce send definition is created.
13. In Marketing Cloud, navigate to **Email Studio**.

 **Note:** Any changes made to an email after you've scheduled a send are reflected in your scheduled send.

14. Click **Salesforce Send Emails** under Interactions.
15. Select a Salesforce send definition.
16. Click **Send**.
17. Select the date and time to start the send.
18. Certify that all recipients have opted to receive the email.
19. Click **Send**.
The send is complete.

Salesforce Data Extensions in Marketing Cloud Connect

A data extension is a table that contains your data. With Marketing Cloud Connect, push tracking data from the Marketing Cloud back to your Sales or Service Cloud orgs using Salesforce data extensions (SFDEs). Push any tracking data for emails sent to SFDE audiences using Marketing Cloud Salesforce Sends to the Salesforce Contact or Lead record in the connected org. SFDEs can use the same Marketing Cloud segmentation and filtering tools as standard data extensions. Data extensions created from sends to reports or campaigns have a hard-coded retention policy of five days.



Note: Not seeing them? Connect users to the CRM on their User Detail record in the Marketing Cloud to access this functionality. The User Detail record shows Integrated for Salesforce.com Status.

Prerequisites

Before you get started with Salesforce data extensions (SFDEs), check the subscriber key, Email field, and field names.

- Use an 18-digit Salesforce Contact or Lead ID (not 15-digit) to map to the subscriber key. If the report field containing the Contact or Lead ID is called Contact ID or Lead ID, subscriber Keys automatically convert from 15 to 18 digits. A field labeled 'ID' uses the 15-digit Contact or Lead ID, which can result in duplicate IDs in the Marketing Cloud. Contact or Lead IDs that are imported into a standard data extension using a manual flat file import are not automatically converted from a 15-digit to an 18-digit subscriber key.
- To import into an SFDE, the email field must be set to type 'email address'. If not, the report is imported into a standard data extension and tracking is not returned to the Sales or Service Clouds.
- Field names cannot contain ? or %.

Follow data extension documentation to learn steps for creating and managing Salesforce Data Extensions.

Importing Salesforce Data Extensions

Import Salesforce data extensions into the Marketing Cloud through Interactions. Create import activities with accessible Sales or Service Cloud reports. For example, if you can't access a report in Marketing Cloud, you can't access it in the Marketing Cloud Admin folder of Sales or Service Cloud.

Manual and automated imports behave differently in scope-by-user accounts:

- Manual import activities respect scoping, so the number of records that appear in the report are specific to the user who is running the import.
- All automated import activities are executed as the Marketing Cloud API User. Therefore, the number of records reflect the Salesforce system user's (tracking user) level of access to data.

With non-scope-by-user accounts, imports return results based on the Salesforce system user's data access.

[Send to a Salesforce Data Extension or Filter](#)

With Marketing Cloud Connect, sending to a Salesforce data extension or Salesforce data extension filter is a two-step process. First, create a Salesforce send email definition. Then send to a Salesforce data extension or data extension filter.

Send to a Salesforce Data Extension or Filter

With Marketing Cloud Connect, sending to a Salesforce data extension or Salesforce data extension filter is a two-step process. First, create a Salesforce send email definition. Then send to a Salesforce data extension or data extension filter.

Create a Salesforce Send Definition

1. In Marketing Cloud, navigate to **Email Studio**.
2. Under Interactions, click **Salesforce Send Emails**.
3. Click **Create**.
4. Enter a name.
5. Under Messages, select the email.
6. Select a Send Classification.
7. Click **Edit Recipients**.
8. Expand **Salesforce Data Extensions**.
9. Select desired Salesforce Data Extension or Salesforce Data Extension Filter.
10. Add the selection to **Targeted**.
11. Save the new send definition.

Send to a Salesforce Data Extension or Salesforce Data Extension Filter

1. In Marketing Cloud, navigate to **Email Studio**.
2. Under Interactions, click **Salesforce Send Emails**.
3. Select a Salesforce data extension or data extension filter.
4. Click **Send**.
5. Select to send immediately or schedule a time to send.
6. Certify opt in.
7. Click **Send**.

Triggered Sends

Use triggered email sends to create and send automated messages to Salesforce contacts, leads, or person accounts when object records are created or updated.

[Understand Marketing Cloud Connect Triggered Sends](#)

Review important prerequisites and learn how to effectively use triggered sends with Marketing Cloud Connect.

[Configure Objects and Triggers](#)

Complete the steps to create triggers, enable objects, and configure triggers with Marketing Cloud Connect.

[Create a Salesforce Triggered Send in Marketing Cloud Connect](#)

To send an automated message through Marketing Cloud Connect, build the Triggered Send.

[Personalize with Custom Objects](#)

Use Custom Objects and AMPscript to personalize your messages in Marketing Cloud Connect.

[Test Object Triggers](#)

Learn about using test scripts before sending triggered emails through Marketing Cloud Connect.

Understand Marketing Cloud Connect Triggered Sends

Review important prerequisites and learn how to effectively use triggered sends with Marketing Cloud Connect.

Automatically send relevant, timely, personalized messages using triggered sends. Welcome emails to new customers or thank you notes for purchases are examples of how triggered sends are commonly used.

Create triggered sends on objects with a lookup to a Contact ID or Lead ID, or to an Account object if person accounts are enabled. After you create a trigger for each object, messages are sent automatically each time update or insert events occur on the objects.

Marketing Cloud Connect enables you to use many features of triggered sends within the Sales or Service Clouds.

- Create and edit Marketing Cloud triggered sends.
- View existing triggered sends across clouds.
- Review aggregate tracking data for triggered sends across clouds.
- Add subscribers to specific data extensions for more marketing opportunities. If no destination data extension is selected, the subscriber is added to the All Subscribers list in the Marketing Cloud. If the user that activated the send does not have access to All Subscribers list, the contact or lead is not added to that list.

Before you begin...

- You need access to All Subscribers list in the Marketing Cloud.
- Ensure that triggered sends are enabled in the Marketing Cloud.
- Set up send classifications in Marketing Cloud for triggered sends. If needed, overwrite send-classifications in Marketing Cloud Connect using the **Override from Name/Email Address**.
- The email associated with the triggered send must pass validation in the Marketing Cloud.



Tip: Follow these best practices and guidelines:

- Triggered sends only work with events that occur after updates and inserts.
- To change the filter criteria or select a new email for your triggered send after creating it through Marketing Cloud Connect, update the triggered send in Sales or Service Cloud. Editing a triggered send in Marketing Cloud, after creating it in Sales Cloud, changes the ID associated with the triggered send, which prevents updates.
- Triggered sends use Apex code. Write and test triggers in a Salesforce developer environment, sandbox, or trial org before publishing to production.
- Triggered sends do not support bulk updates or inserts.
- Marketing Cloud Connect is governed by SOQL query limits. Each evaluation of a triggered send uses one query toward the SOQL limit of 100 at one time. To reduce the number of queries performed, use the `automateByName` Apex method.
- You can execute up to 50 triggered sends within a transaction, including a bulk record update or sends that meet filter criteria for a single record.

Configure Objects and Triggers

Complete the steps to create triggers, enable objects, and configure triggers with Marketing Cloud Connect.



Note: Permission for Triggered Sends Configuration is required to complete these tasks.

1. From Sales or Service Cloud, click **Setup**.
2. Under Build, click **Customize**.
3. Select desired object.
4. Click **Triggers**.

5. Click **New**.
6. In the Apex Trigger window, select **Is Active**.
7. Enter the following code, substituting the desired object name where indicated with **Object Name**.

```
trigger Trig_Object Name on Object Name (after insert, after update) {
    et4ae5.triggerUtility.automate('Object Name'); }
```

For example:

```
trigger Trig_Lead on Lead (after insert, after update) {
    et4ae5.triggerUtility.automate('Lead'); }
```

8. Save the trigger.
The trigger is created for the object.
9. Click the **Marketing Cloud** tab.
10. Click **Configure Marketing Cloud Connect**.
11. Click **Edit Settings**.
12. Under Triggered Sends, select **Restriction** to set user permissions and restrictions.
13. Under Triggered Sends, add **Enabled Objects** to be used for triggered sends.
14. Save the settings and selections.
The restrictions are set and objects enabled.

Create a Salesforce Triggered Send in Marketing Cloud Connect

To send an automated message through Marketing Cloud Connect, build the Triggered Send.

 **Note:** Permission for Triggered Sends Configuration is required to complete these tasks.

1. From Sales or Service Cloud, click the **Marketing Cloud** tab.
2. Click **Triggered Sends**.
3. Click **New**.
4. Enter a **Name**.
5. Choose an **Object**.

 **Tip:** If you select an object with more than 1,000 fields, only the first 1,000 fields are available for selection.

6. Select the **Recipient Lookup** source field that has the lookup relationship to the recipient source.
For example, select **Contact ID** for the Contact Object, or select **Lead ID** for the Lead Object. Only one lookup field can be selected.
7. Customize **Field Criteria** for the event trigger as necessary, to a maximum of 9 criteria.
 - a. To add field logic options, click **+**.
 - b. To specify whether each criteria is in addition (AND) or an alternative (OR), click .
For example, 1 AND 2.

8. To determine the actions on the record that warrant evaluation for a send, select an option for **Trigger send when**.
For example, you configure a trigger and intend for it to send a single time for the first match found. You configure the trigger to send an email when Checkbox A is set to Yes. If you set the **Trigger send when** to **new record is created or existing record is updated**, when Checkbox A is set to **Yes**, the Triggered Send email is triggered every time that record is updated, as long as Checkbox A is set to **Yes**.
9. Choose a **Business Unit** if applicable.
10. Select an **Email** for sending when the trigger activates.
11. To review emails with dynamic, personalized content using real Contact or Lead data before sending, click **Preview Email**.
12. **Subject line** populates with the subject of the selected email. You can overwrite the subject line as necessary.
13. Select a **Send Classification**.
14. Specify the **Send Time**.
15. Certify that all recipients opted in to receive the email.
16. Save the triggered send.
17. To begin sending the triggered send, click **Activate**.

 **Note:** Deactivate the triggered send before editing.

Personalize with Custom Objects

Use Custom Objects and AMPscript to personalize your messages in Marketing Cloud Connect.

Use custom objects associated to a contact or lead for personalization in triggered sends from the Sales and Service Clouds. Use AMPScript with custom objects for more personalization.

For example, instead of sending generic replies such as, "Susan, your case has been closed," use custom objects to personalize the reply as "Susan, your Case ABC123XYZ, 'Unable to Send' was closed at 11:29PM by John Smith."

Sample:

```
%%[
Set @mySObject = SObject
Set @myRecordId = RecordId
set @Case = RetrieveSalesforceObjects(SObject,"Subject,Status","Id", "=", RecordId)
Set @CaseRow = Row(@Case, 1)
Set @Subject = FIELD(@CaseRow, "Subject")
Set @Status = FIELD(@CaseRow, "Status")
]%%
<br><br>
SObject From API Call: %%v(@mySObject)=%% <br>
RecordId From API Call: %%v(@myRecordId)=%% <br>
Subject From RetrieveSalesforceObjects: %%v(@Subject)=%% <br>
Status From RetrieveSalesforceObjects: %%v(@Status)=%% <br>
```

Test Object Triggers

Learn about using test scripts before sending triggered emails through Marketing Cloud Connect.

Provide a test script before moving object triggers into production. Repeat the script for each object with a trigger setup. Ensure that the object's defined properties account for all required properties on an object.

This example test script is specific to the Contact object. This example has LastName='TestExample.'

```
{  
  
    private static testmethod void ContactTriggerTest()  
  
    {  
  
        insert new et4ae5__Configuration__c(et4ae5__Support_Ticket_Recipient__c =  
'example@example.com');  
  
        Test.startTest();  
  
        Contact c = new Contact(LastName='TestExample');  
  
        // Insert contact  
  
        insert c;  
  
        // If no exceptions occurred, it was successful  
  
        System.assert(!String.isBlank(c.Id));  
  
        Test.stopTest();  
  
    }  
  
}
```

Synchronized Data Sources in Contact Builder

Synchronized Data Sources in Contact Builder bring data from across the Salesforce Customer Success Platform into your Marketing Cloud account. Synchronized Data Sources synchronize data from your Salesforce account at prespecified time intervals, including data schema and relationships previously established in your Salesforce CRM account.

Synchronized Data Sources Prerequisites

To use Synchronized Data Sources, your account must use Contact Builder and Marketing Cloud Connect (version 5). Contact your Marketing Cloud account representative to enable Synchronized Data Sources.

Ensure that your Salesforce System User account remains active and that you know the password.

When integrating multiple business units in your account, use a single integration user for no more than five business units.

Complete the implementation for your Sales or Service Cloud org and allow that org to completely populate with data before you set up your Synchronized Data Sources. This step allows the process to complete with less load on the system.

 **Note:** Marketing Cloud Connect currently uses version 51 of the Salesforce SOAP API WSDL. Because the API version may not be the latest production version available, some new objects or features may not be supported in Synchronized Data Sources.

Synchronization and Synchronized Data Sources

Synchronized Data Sources let you use information from Sales Cloud and Service Cloud sources as part of your marketing activities:

- Personalization using up-to-date information from multiple sources
- Dynamic content using information from multiple sources
- Additional information from Salesforce Custom Objects
- Track synchronization using an activity log and Contact Builder with Synchronized Data Sources.

Multi-Org and Synchronized Data Sources

Synchronized Data Sources permit a single active Salesforce system user to connect to multiple business units within a Marketing Cloud account. Each business unit that connects using the same active Salesforce system user integrates using the same data model. That integration ensures that these integrated business units receive the same data synchronized from Sales Cloud and can access that data for use in marketing activities. Actions taken to update a data source, such as adding or removing a field, reflect in all business units integrated with the Salesforce system user. Because these actions can affect multiple business units, understand the implications of any data source change in a multi-org environment. We support up to five business units to the same tracking user in a multi-org environment. If you use more than five business units, service can be degraded and can negatively impact the servers.

Time Zones and Synchronized Data Sources

Date and time information synchronized from the Sales Cloud to the Marketing Cloud change from the specified Sales Cloud time zone to CST in Marketing Cloud. For example, a birthday stored as 09/29/2019 00:00 AM in the Sales Cloud in GMT changes to 09/28/2019 07:00 PM in the Marketing Cloud. Ensure that you use the proper offset when manipulating date and time information synchronized from the Sales Cloud to the Marketing Cloud. The Marketing Cloud application displays date and time values based on the time zone and date settings for each user account.

[Create Synchronized Data Sources in Contact Builder](#)

Data sources available for synchronization appear after you integrate your account using Marketing Cloud Connect. Link your Marketing Cloud Connect data source into Contact Builder. The synchronized data source appears in your Data Sources when complete. This process takes some time to complete.

Create Synchronized Data Sources in Contact Builder

Data sources available for synchronization appear after you integrate your account using Marketing Cloud Connect. Link your Marketing Cloud Connect data source into Contact Builder. The synchronized data source appears in your Data Sources when complete. This process takes some time to complete.

This process creates a single data extension within your Marketing Cloud account with one column for each field you choose to synchronize. The synchronized data extension uses the name of the synchronized object and adds the suffix `Salesforce_n`, where `n` indicates the number of the copy when used in a multi-org environment. For example, if you synchronize the Contact data source, that data source appears in your Marketing Cloud account as `Contact_Salesforce_1`.

To ensure that the object is available to sync, these criteria must be met:

- Queryable: True

- Creatable: True
- Retrievable: True
- Replicateable: True
- CustomSetting: False

 **Note:** An object must have a CreatedDate field available for synchronizing.

All columns use the specified data type and data length. As you add, delete, or change data in Service Cloud or Sales Cloud, these changes occur in Marketing Cloud based on the Poll Schedule setting. Marketing Cloud uses the same data model for your entities within the Contact Builder data model. Your customer interactions within Journey Builder use the primary and foreign keys to define the relationships that inject your contacts in as necessary.

1. Select the **Data Sources** tab in Contact Builder.
2. Select the **Synchronized** tab.
3. Select the data source connected via account integration.
4. Click **Set Up Object**.
5. Click **Synchronize** for the entity containing the data to bring into Contact Builder.
6. To synchronize, select the checkboxes next to the fields and click **Next**.
7. Filter the synchronized records you choose to import using the **Records Collection** buttons.
 - a. To import all records, select **All records**.
 - b. To import only records with an email address, select **All records with an email address**.
 - c. To import only records created after a specified date, select **All records created since** and specify the date.
 - d. To use a Boolean filter to import records, select **All records with** and enter the Boolean value. Select an attribute, set the operator, and choose **True** or **False**.

For better performance, implement data filters on your synchronized records using the **Records Collection** buttons. You can choose a specified date that synchronizes only the records you need for your activities. Filter out any records that don't include an email address record to prevent duplicate contact records in your Marketing Cloud account. Finally, you can use Boolean filters to narrow the range of imported records.

8. Choose how often you wish the synchronize data in the **Poll Schedule** dropdown menu.
9. Click **Save**.

 **Note:** You can't change relationships between synchronized objects after the initial sync.

Each data source displays both a name and the external API key for the object. Use these names to locate your information and manage your synchronized data extensions. Synchronized Data Sources displays row counts during the initial synchronization and refreshes every 30 seconds.

-  **Note:** When new objects are synchronized, object relationships are prioritized in this order:
- System-defined standard object relationships
 - Standard reference ID fields, in alphabetical order
 - Custom reference ID fields, in alphabetical order

Journey Builder Integration

Journey Builder is a Marketing Cloud application used for creating responsive automated multi-channel campaigns. Use Journey Builder to design a communication plan that reaches customers at every stage of their journey with your brand. Configure Marketing Cloud Connect in your org to access specific Journey Builder features within the Sales or Service Clouds. For example, add a lead, contact, or a user to a journey, or update a Salesforce object as a step in the journey.

Sales and Service Cloud Activities

Use Sales and Service Cloud canvas activities in Journey Builder to create or update Sales and Service Cloud object records for connected Marketing Cloud contacts. You can grant new users access to create or edit Sales and Service Cloud Activities, except users with the Marketing Cloud Administrator role.

The Salesforce Data Event

A Salesforce Data Event is an action in Sales Cloud or Service Cloud, such as creating or updating an object record, that injects a contact into a journey. When the primary object meets rule criteria and reference object filtering criteria, Flow Builder initiates a Journey Builder event.

Sales and Service Cloud Activities

Use Sales and Service Cloud canvas activities in Journey Builder to create or update Sales and Service Cloud object records for connected Marketing Cloud contacts. You can grant new users access to create or edit Sales and Service Cloud Activities, except users with the Marketing Cloud Administrator role.

Sales Cloud activities use the Salesforce SOAP API to Create, Lookup, and Update. There are three options when you configure an activity: Create, Simple Update, and Find and Update. A successful create or update stores the generated record ID as output data for the activity that you can access through Journey Data.

 **Note:** Activities are asynchronous. It's possible that the update to Sales Cloud isn't instantaneous depending on how many updates to Sales/Service Cloud you're making. Allow up to 24 hours to process the update. We only retry failures with the "UNABLE_TO_LOCK_ROW" errors. We retry up to 10 times for row-locking errors.

The activities use the same version of the Salesforce SOAP API as the Marketing Cloud Connector.

 **Note:** Complete the steps to configure a Sales and Service Cloud activity when you copy them on the Journey Builder canvas.

Use activities to perform these actions:

- Create a lead when a Marketing Cloud contact enters a journey.
- Update a lead based on engagement within a journey.
- Create a CRM contact record when a Marketing Cloud contact reaches the activity.
- Update a CRM contact record with Marketing Cloud contact data.
- Update a custom object based on engagement within a journey.
- Create a task when another object, such as a lead or contact, enters a journey.
- Associate a case or task to an account.
- Update a task based on a contact or lead's response in a journey.
- Update a person or business account.

Sales and Service Cloud Activity Types

Object activity	Creates or updates a standard Salesforce object record, such as a lead, task, or custom object, when a contact in the journey reaches this activity. Use this activity to create or update a standard Salesforce object record, such as a lead or task, or a custom object record.
Campaign Member activity	Creates a connection between campaigns, contacts, and leads, which helps define a relationship to the status within a campaign. Use this activity to track important moments of engagement throughout the journey.
Convert Lead activity	Converts qualified leads from the Sales and Service Cloud into a contact or account. This activity schedules important actions, such as assigning a lead owner, creating an opportunity or task, and changing the lead's conversion status.
Task activity	Create a task in Sales and Service Cloud for each Marketing Cloud contact that reaches this activity. For more information, see Marketing Cloud Connect .
Account Activity	Creates or updates an account in Sales and Service Cloud for each contact that reaches this activity. If you have a Person Account, you can create or update both Business and Person Account activities. To learn more about how to configure activities with Person Accounts, see Use Person Accounts with Sales and Service Cloud Activities .
Contact Activity	Creates or updates a contact from Sales or Service Cloud using Sales or Service Cloud data brought into a journey or Marketing Cloud contact data.
Case Activity	Creates a case and associates it to the Sales and Service Cloud contact that matches the Marketing Cloud contact's ID. Or create a Sales and Service Cloud contact to associate to the case.
Lead Activity	Creates or updates a lead from Sales or Service Cloud using Sales or Service Cloud data brought into a journey or Marketing Cloud contact data.
Opportunity Activity	Creates an opportunity record in Sales and Service Cloud. Use Marketing Cloud contact attributes to populate the fields in the opportunity record, or populate each record with fixed values you choose.
Legacy Activities	These Sales and Service Cloud canvas activities appear in old journeys but are no longer available to use in new journeys.

The Salesforce Data Event

A Salesforce Data Event is an action in Sales Cloud or Service Cloud, such as creating or updating an object record, that injects a contact into a journey. When the primary object meets rule criteria and reference object filtering criteria, Flow Builder initiates a Journey Builder event.

 **Note:** You can grant users access to create or edit Salesforce events, except users with the Marketing Cloud Administrator role.

Consider these items when you configure the event:

- Use the Sales Cloud or Service Cloud object as the source of the entry event
- Who enters the journey, such as users, leads, or contacts
- When the user, lead, or contact enters the journey, such as when a record is created or updated
- Select attributes from object data to filter who enters the journey
- Select fields from related objects and the entry object to use for journey data

 **Note:** Limit selection to 250 fields or less. Limit journeys per object to 80 or less.

Each record includes the ID for the user, lead, or contact entering the journey, their email address, and the email opt-out flag status.

After the entry source is configured, you can't edit the object it uses or who enters the journey. To choose a different object, delete and recreate the entry source. You can edit the entry criteria, filters, and event data for a configured entry source before it's published. You can copy journeys that contain Salesforce entry sources and entry sources are reusable.

 **Note:** Salesforce entry sources are only editable when no other running journey or version uses them.

After you save the entry source, Marketing Cloud creates a data extension that uses event data as columns and the contact ID as the Subscriber ID. Records that meet the entry source criteria are imported into this data extension when the journey is published. A row is created in the data extension every time a record meets the criteria, but existing rows aren't updated. You can have the same record in the data extension multiple times when it enters the journey more than one time. For more details, see [Journey Settings](#).

 **Note:** The Test Mode feature in Journey Builder doesn't support Salesforce Entry Sources.

The integration between Marketing Cloud and Sales Cloud uses [Flows](#), [Process Builder](#), [Apex](#), [Platform Events](#), and [SOAP APIs](#). Therefore, Salesforce Data Events are subject to all APEX Governor Limits. Adding Journey Builder events or your own processes or flows into the save order of an object can expose or exceed limits within your org. When an integrated journey is activated, the Sales Cloud [Flow Metadata API](#) launches the flow for the object with the conditions specified in the entry configuration. These tools allow your business to run behind the scenes. Here's an example that illustrates how the objects are used and how they work from end to end.

APEX Governor Limits

Salesforce Data Events are subject to all APEX limits, or governors, and process limits within the platform. Introducing Journey Builder Events or Process Builder and Flows into the save order of an object can expose or exceed limits within your org.

- 50 Future invocations: Before the 5.496 Marketing Cloud Connect package, Journey Builder made direct callouts using the future annotation. This action causes an error on any transaction exceeding 50 records, meeting the Journey Builder Event criteria. To avoid this error, use Marketing Cloud Connect package 5.496 or above.
- Transactions with more than 2,000 records: A save transaction is limited to less than 2,000 flow invocations. This limit allows up to 2,000 records to enter a flow within a transaction. If multiple flows are triggered or your org has custom logic generating transactions with more than 2,000 records, the flow invocation fails. To interact with a smaller number of objects, modify transactions.
- Maximum CPU Time: The event adds steps to the target objects save order transaction, which uses a small portion of the allocated CPU for a transaction. To avoid exceeding this limit, monitor the addition of processes.

- 50 System.enqueueJob limit: Each Journey Builder callout is queued as an invocable method. Each transaction can enqueue up to 50 invocable methods and can process up to 200 records. If objects meet the criteria for multiple events, this limit can be reached with 50 unique events on a single object. This limit is shared with non-Journey Builder triggers and flows.

Associated Sales or Service Org Changes

If the Sales or Service Cloud org connected to the Marketing Cloud account changes, delete all associated journeys and events. Journeys can reference objects or fields that don't exist in the new org and cause publishing to fail. Create journeys and events to reference the new org.

Known Issues

- [Platform Events Apex Job runs before update transaction is complete](#)
- [Journey Builder Salesforce Integration Events will not always fire if another Process Builder finishes later in the same transaction](#)
- If one contact in the batched API call to the Marketing Cloud fails, the entire batch fails to inject.